



INSTALLATION INSTRUCTIONS



2019-2020 GM 1500 4WD 3" BALL JOINT UCA SUSPENSION KIT FTS21248

NOTE: TO ORDER WEARABLE REPLACEMENT COMPONENTS DO NOT USE PART NUMBERS SHOWN ON THIS INSTRUCTION SHEET. GO TO FABTECH WEBSITE AND LOOK UP WEARABLE REPLACEMENT PARTS TO FIND THE PROPER PART NUMBER TO ORDER.

Fabtech Motorsports | 4331 Eucalyptus Ave. Chino, CA 91710

Tech Line: 909-597-7800 | **Fax:** 909-597-7185 | **Web:** www.fabtechmotorsports.com

- PARTS LIST -

FTS21248 3" UCA BALL JOINT KIT		
1	FT20833	BALL JOINT UPPER CONTROL ARM (DRIVER)
1	FT20834	BALL JOINT UPPER CONTROL ARM (PASS)
4	FT1500U	UBOLT 9/16-18 X 10.00 X 2.63
2	FT20619	UPPER BALL JOINT
2	FT20801	COILOVER SPACER
1	FT90169	BUSHING KIT
2	FTBK15	BLOCK 1.5"
1	FT20838	HARDWARE SUBASSEMBLY

FT20838 HARDWARE SUBASSEMBLY		
1	FT21248i	INSTRUCTIONS
2	FT20835	SPRING PERCH SPACER
8	FT20836	CONTROL ARM SPACER
1	FT20837	HARDWARE KIT
1	FTAS12	STICKER FT BLUE 10X4
1	FTAS16	DRIVER WARNING DECAL
1	FTREGCARD	REGISTRATION CARD
4	FT1037	BUSHING
4	FT1038	BUSHING
4	FT626	SLEEVE
1	FTLUBE	URETHANE GREASE PACKET

FTS21253 ADAPTIVE RIDE CONTROL SPACER KIT		
2	FT20832	SPRING PERCH SPACER
2	FT20673BK	REAR SHOCK BRACKET
1	FT20874	HARDWARE KIT

FT20874 - HARDWARE KIT		LOCATION
2	1/2-13 X 3-1/2" HEX BOLT	REAR SHOCK
4	1/2" SAE WASHER	
2	1/2-13 C-LOCK NUT	
2	M6-1.0 NUT	CONTROL ARM
1	THREAD LOCKING COMPOUND	

FT20837 - HARDWARE KIT		LOCATION
8	9/16 SAE WASHER	UBOLT
8	9/16-18 NYLOCK NUT	
4	7/16-14 X 2-1/2 HEX BOLT	LOWER STRUT
14	7/16 SAE WASHER G8 ZINC	
4	7/16-14 C-LOCK NUT ZINC	
6	7/16-14 NYLOCK NUT	COILOVER SPACER
8	5/16-18 C-LOCK NUT	BALL JOINT
16	5/16" SAE WASHER	
8	5/16-18 X 1" HEX BOLT	
4	FT84 GREASE FITTING 1/4-28	
4	ZIP TIE 8" BLACK	
1	THREAD LOCKING COMPOUND	
4	M14-2.0 X 100MM HEX BOLT	CONTROL ARM
8	M14 FLAT WASHER	
4	M14-2.0 C-LOCK NUT	

- TOOL LIST -

Required Tools (Not Included)

- Basic Hand Tools
- Floor Jack
- Jack Stands
- Assorted Metric and S.A.E sockets, and Allen wrenches
- Torque Wrench
- Die Grinder w/ Cutoff Wheel or Sawzall
- Coil spring compressor

- PRE-INSTALLATION NOTES -

For technical assistance call: **909-597-7800** or e-mail: **info@fabtechmotorsports.com**

READ THIS BEFORE YOU BEGIN INSTALLATION -

Check all parts to the parts list above before beginning installation. If any parts are missing contact Fabtech at 909-597-7800 and a replacement part will be sent to you immediately.

Read all instructions thoroughly from start to finish before beginning the installation. If these instructions are not properly followed severe frame, driveline and / or suspension damage may occur.

Check your local city and state laws prior to the installation of this system for legality. Do not install if not legal in your area.

Prior to the installation of this suspension system perform a front end alignment and record. Do not install this system if the vehicle alignment is not within factory specifications. Check for frame and suspension damage prior to installation.

The installation of this suspension system should be performed by two professional mechanics.

This suspension must be installed with Fabtech shock absorbers.

Installation of all fasteners requires the use of provided thread locking compound with proper torque values as indicated throughout the installation. Apply thread locking compound upon the final torque of the fastener.

WARNING- Installation of this system will alter the center of gravity of the vehicle and may increase roll over as compared to stock.

Vehicles that receive oversized tires should check ball joints, uniballs, tie rods ends, pitman arm and idler arm every 2500-5000 miles for wear and replace as needed.

Verify differential fluid is at manufactures recommended level prior to kit installation. Installation of the kit will reposition the differential and the fill plug hole may be in a different position. (For example, if the manufacture recommends 3 quarts of fluid, make sure the diff has 3 quarts of fluid). Check your specific manual for correct amount of fluid.

FOOTNOTES -

- Can not use OEM wheel and tire.
- Does not fit standard cab.
- Does not fit GMC AT4 or Chevy Trail Boss models
- Does not fit 2019 Silverado LD or 2019 Sierra Limited models. Use 2018 applications for these vehicles.

- INSTRUCTIONS -

FRONT SUSPENSION

1. Disconnect the negative terminal on the battery. Jack up the front end of the truck and support the frame rails with jack stands. **NEVER WORK UNDER AN UNSUPPORTED VEHICLE!** Remove the front tires. **IMPORTANT:** Using a paint pen mark straight line down the center of the coilover at the top cap, lower spring perch and the lower mount to the control arm. **SEE FIGURE 1**

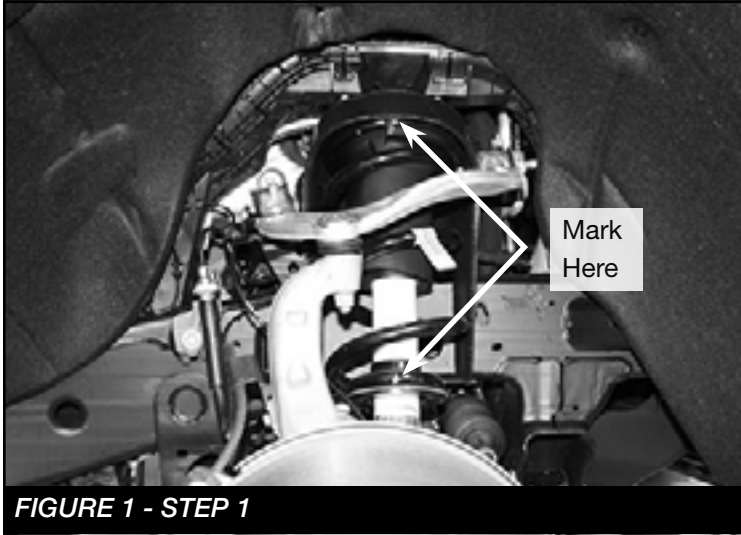

2. Starting with the passenger side. Disconnect the ABS wire bracket from the upper control arm and the brake line bracket from the knuckle. Save hardware. **SEE FIGURES 2-3**

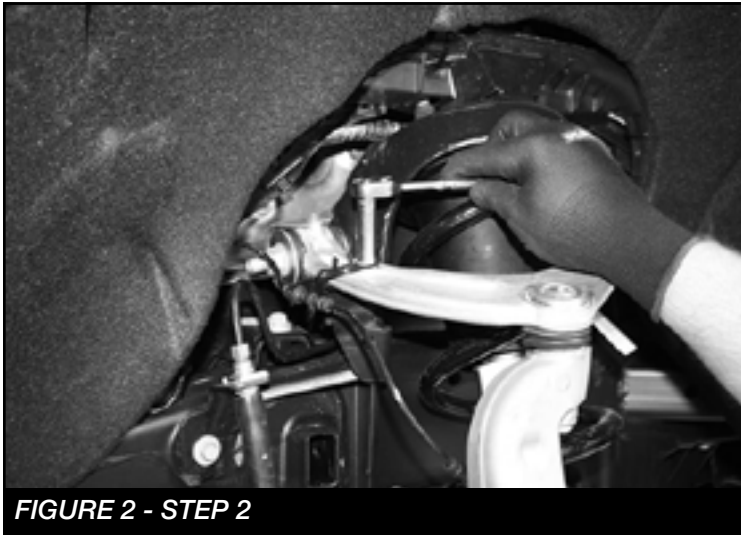

3. Remove the factory tie rod end nut and strike the knuckle with a hammer till the tie rod end comes loose. Save all hardware. Use care not to hit any other parts. **SEE FIGURES 4-5**

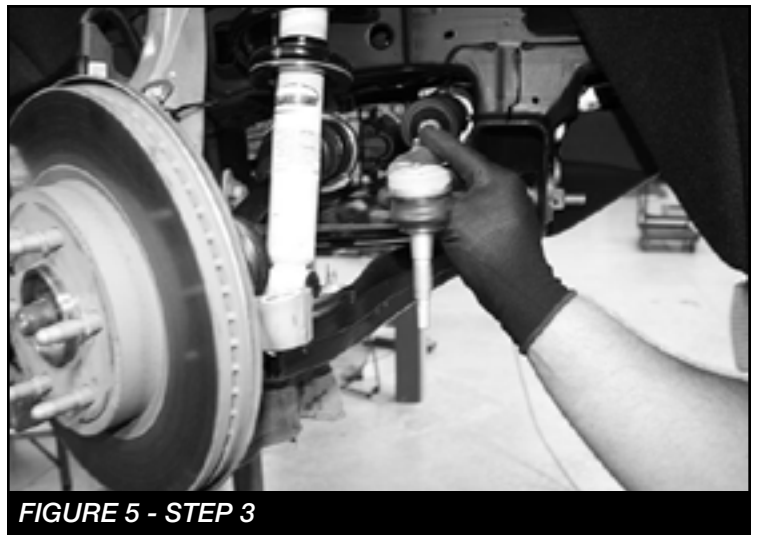
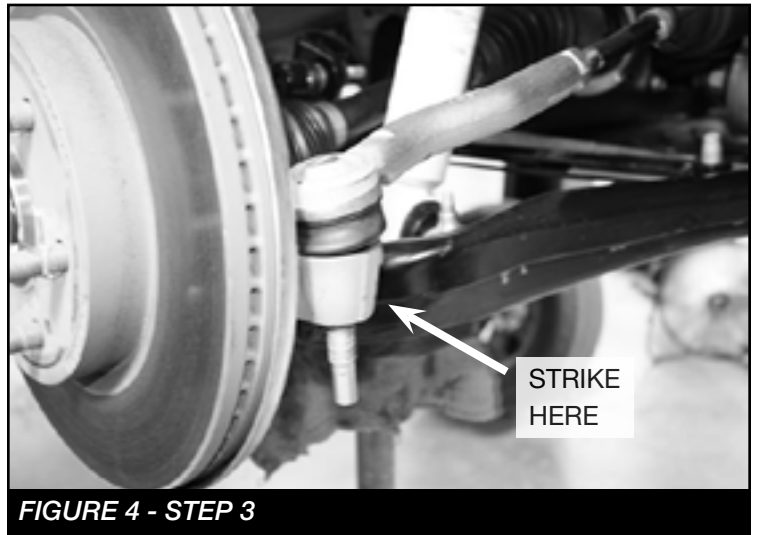

4. Using a 36mm socket, remove and save the axle hub nut. **SEE FIGURE 6**



FIGURE 6 - STEP 4

5. Remove and save the sway bar link nut from the bottom side of the lower control arm. **SEE FIGURE 7**



FIGURE 7 - STEP 5

6. Loosen the upper ball joint nut and strike the knuckle with a hammer until it comes loose from the upper control arm. Next, remove the factory nut. Then, detach the knuckle from the upper control arm. Push the knuckle to the side and secure if possible. **SEE FIGURE 8**

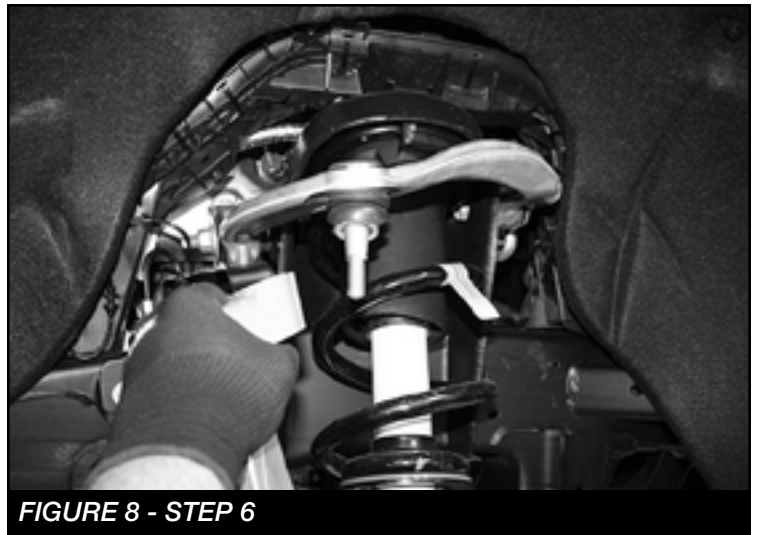

FIGURE 8 - STEP 6

7. Locate the plastic wire harness channel on the top of the passenger side coilover mount. Push it up and back to allow access to the three coilover nuts. Remove and discard the upper coilover nuts. **Adaptive Ride Control models only: Disconnect the wiring plug from the lower strut body and disconnect the adjusting rod from the upper control arm. SEE FIGURES 9-10**



FIGURE 9 - STEP 7



FIGURE 10 - STEP 7

8. Remove and discard the two lower coilover bolts. Then remove the coilover assembly from the vehicle. **SEE FIGURES 11-12**



FIGURE 11 - STEP 8

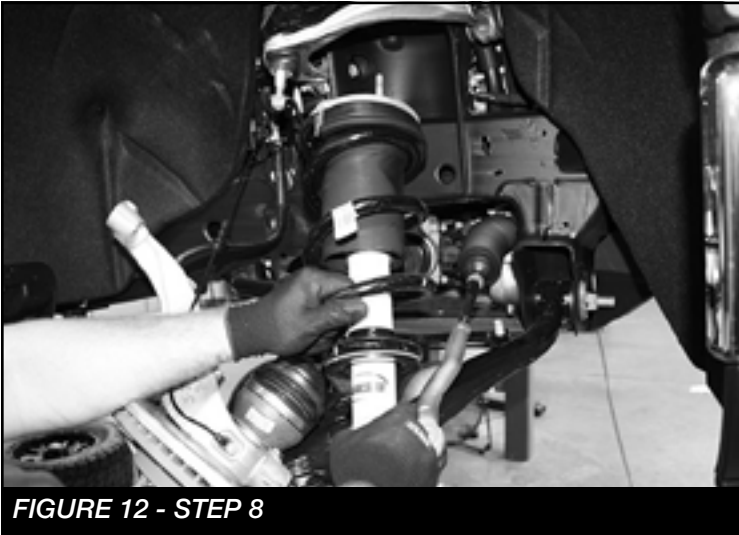

FIGURE 12 - STEP 8

9. Remove the factory upper control arm from the vehicle and save the hardware. Repeat steps 1-8 on the driver side.
- IF INSTALLING DIRT LOGIC COILOVERS REFER TO THE INSTRUCTIONS PROVIDED THEN SKIP TO STEP 23
10. **NOTE: If vehicle is equipped with Adaptive Ride Control skip to Step 16.** Using a coil spring compressor. Carefully compress the coil spring until there is no pressure on the upper top cap. Loosen and remove the top cap nut then top cap and dust boot. **SEE FIGURES 13-14**

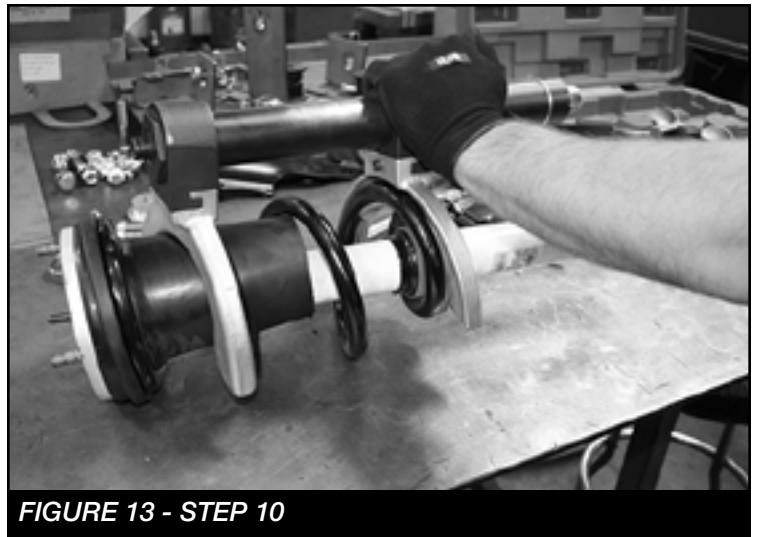

FIGURE 13 - STEP 10



FIGURE 14 - STEP 10

11. Remove the coil from the strut and set aside.
12. Remove the bump stop cap and save. Then, slide off the lower coil spring perch. **SEE FIGURES 15-17**



FIGURE 15 - STEP 12

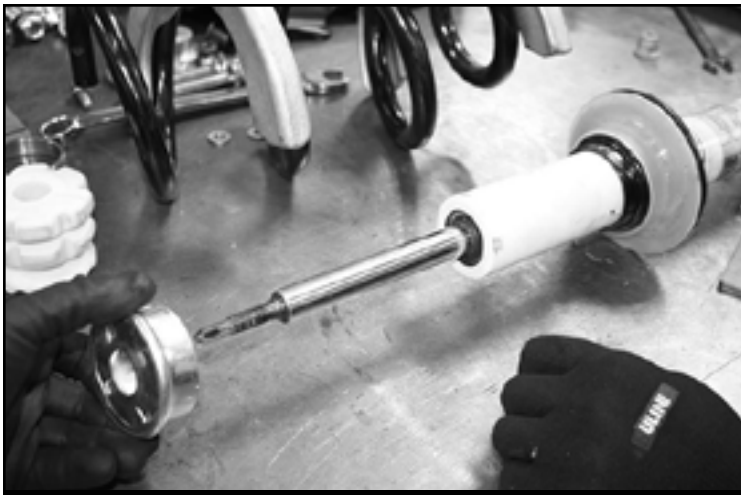

FIGURE 16 - STEP 12



FIGURE 17 - STEP 12

13. Install FT20835 (Spring perch spacer) onto the strut. **Note:** the machined groove will seat around the lip on the strut body. SEE FIGURES 18-19

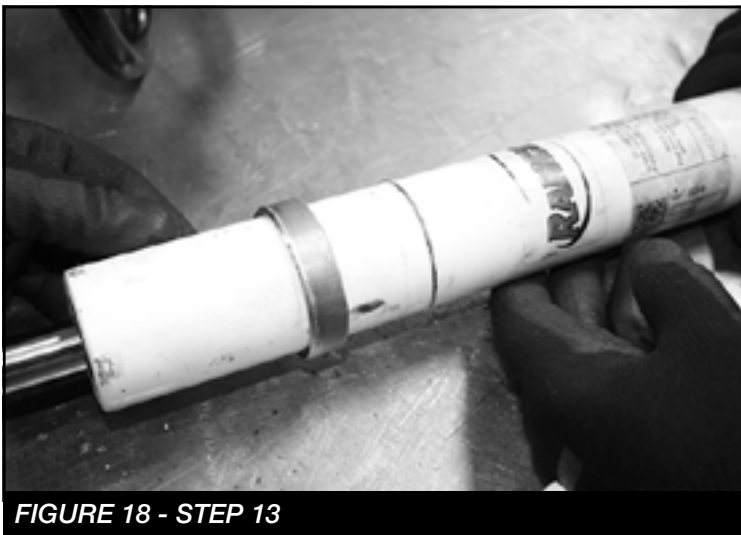

FIGURE 18 - STEP 13

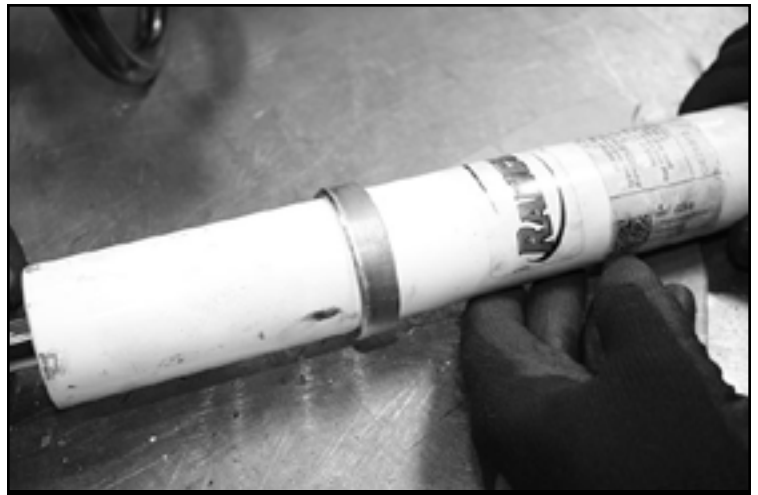

FIGURE 19 - STEP 13

14. Reinstall the lower spring perch. **SEE FIGURE 20**

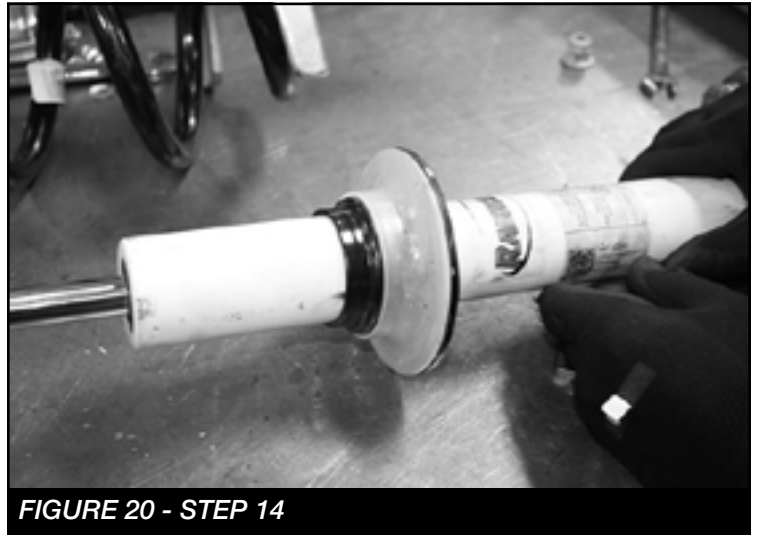

FIGURE 20 - STEP 14

15. Reinstall the bumpstop cap, compressed coil spring and the top cap and nut. **NOTE:** Before you remove the compressor make sure your marks are lined up from the top cap, lower perch and lower mount that were marked in step 1. Torque the top cap nut to 35 ft-lbs.

16. ADAPTIVE RIDE CONTROL ONLY: Using a coil spring compressor. Carefully compress the coil spring until there is no pressure on the upper top cap. Loosen and remove the top cap nut then top cap and dust boot. Remove coil and set aside. **SEE FIGURES 21-23**

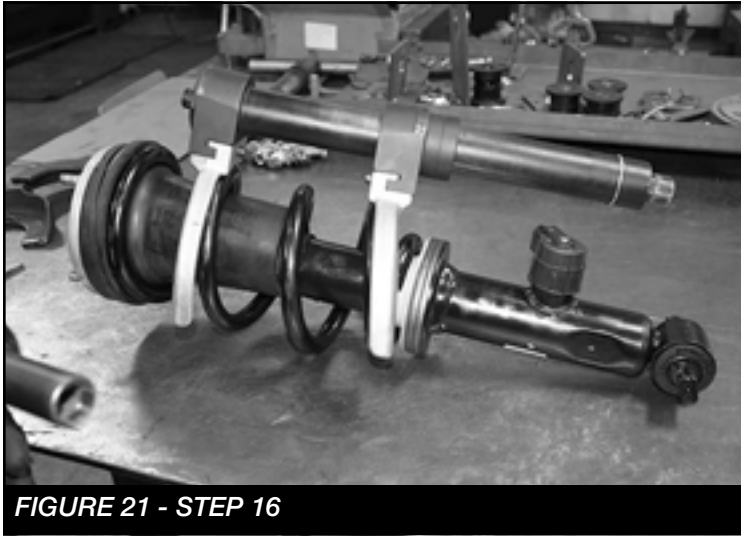

FIGURE 21 - STEP 16



FIGURE 22 - STEP 16



FIGURE 23 - STEP 16

17. Remove the foam bump stop, struct body cap and save. Then, slide off the lower coil spring perch plastic isolator. **SEE FIGURE 24**



FIGURE 24 - STEP 17

18. Install FT20832 (Spring perch spacer) onto the strut. Then, reinstall the plastic isolator onto the new spacer. Reinstall the cap and foam bumpstop. **SEE FIGURES 25-28**

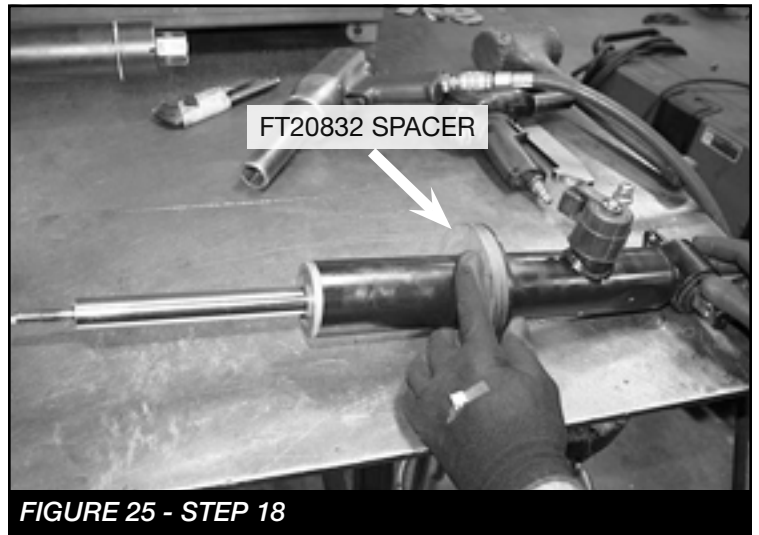

FIGURE 25 - STEP 18

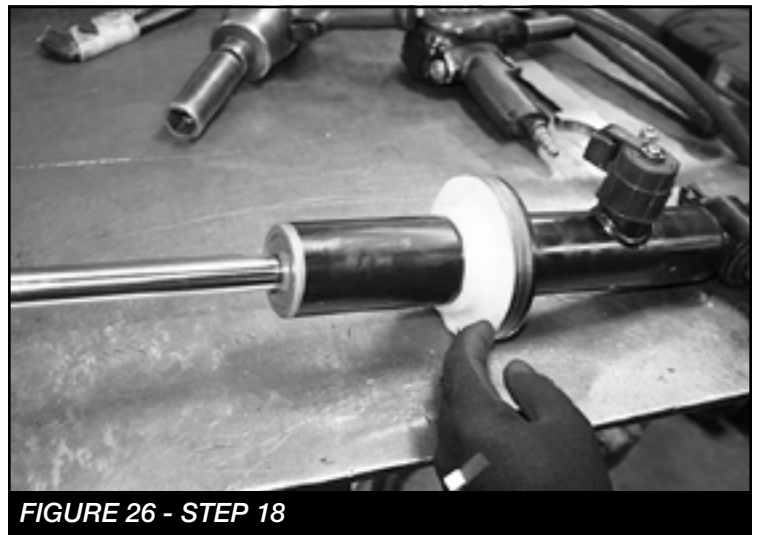

FIGURE 26 - STEP 18

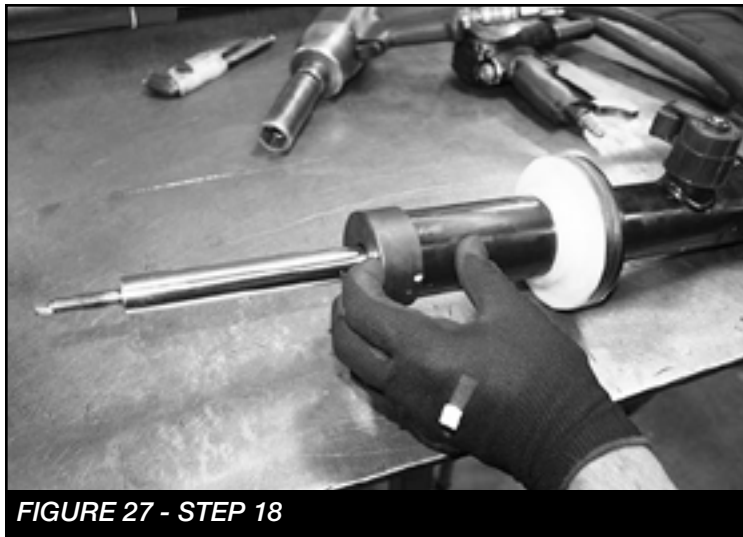

FIGURE 27 - STEP 18



FIGURE 28 - STEP 18

19. Reinstall the bumpstop cap, compressed coil spring and the top cap and nut. **NOTE: Before you remove the compressor make sure your marks are lined up from the top cap, lower perch and lower mount that were marked in step 1.** Torque the top cap nut to 35 ft-lbs.

20. Locate the three top cap studs. Measure and mark 1-1/8" from the base of the studs. Using a cut off wheel, cut the excess of the stud off. **SEE FIGURE 29**

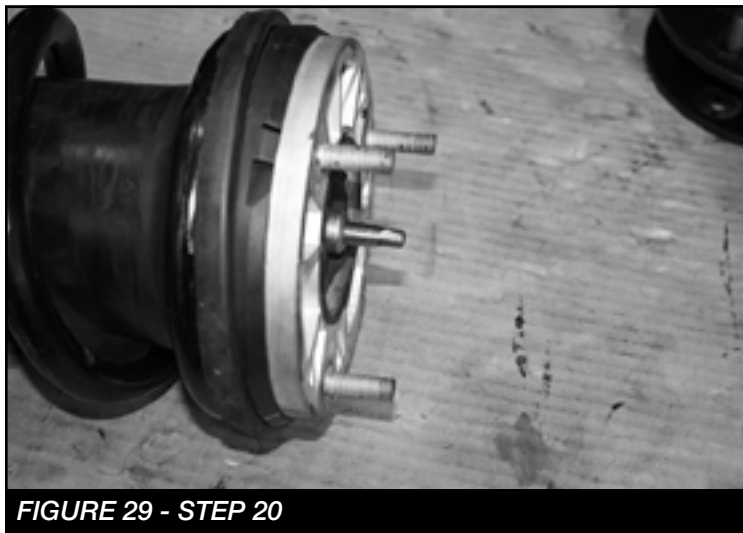

FIGURE 29 - STEP 20

21. Install FT20801 (Coilover spacer) onto the factory strut using the factory hardware. Torque to 68 ft-lbs. **SEE FIGURE 30**

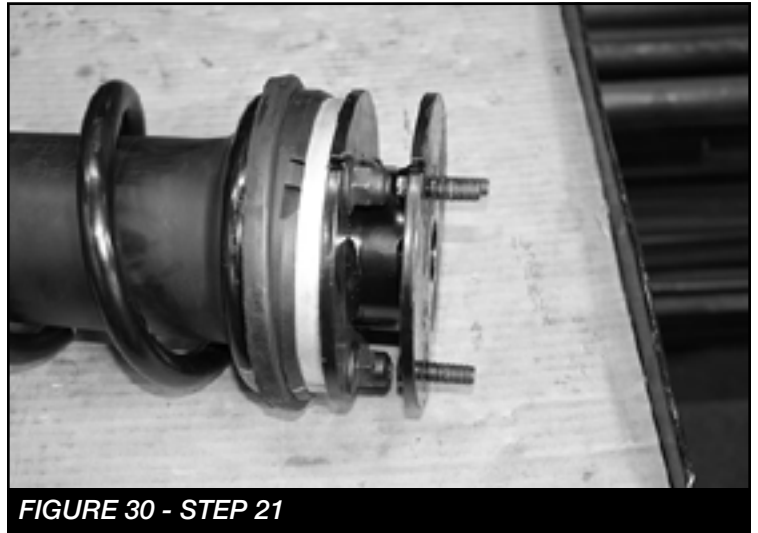

FIGURE 30 - STEP 21

22. Repeat steps on the driver side.

23. Locate the new Fabtech control arms, two FT1038 bushings, two FT1037 bushings, two FT84 grease zerks, and two FT626 sleeves. Using the supplied grease packet, grease the bushings and sleeves before installing into the control arm. **SEE FIGURE 31**

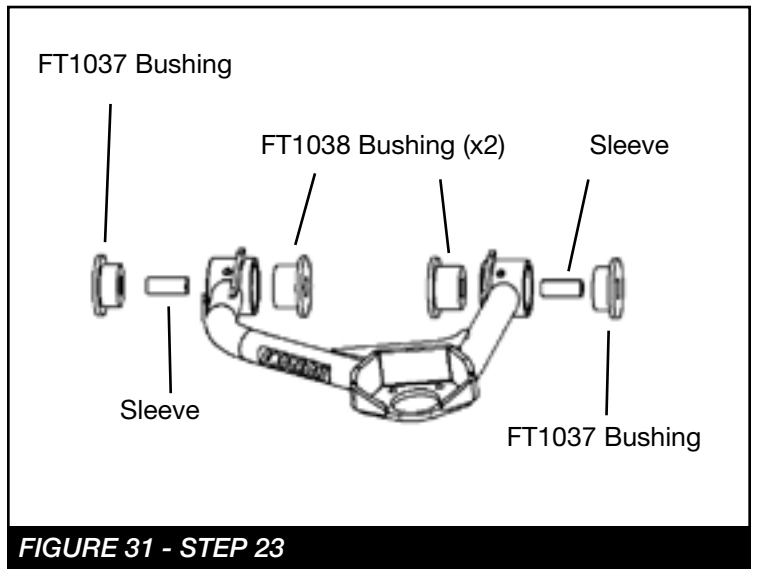

FIGURE 31 - STEP 23

24. Install FT20619 (Ball joint) onto the new upper control arm using the supplied 5/16"-18 x 1" bolts, washers and nuts from the hardware kit. Lube ball joint through zerk fittings. Torque to 29 ft-lbs. **SEE FIGURE 32**

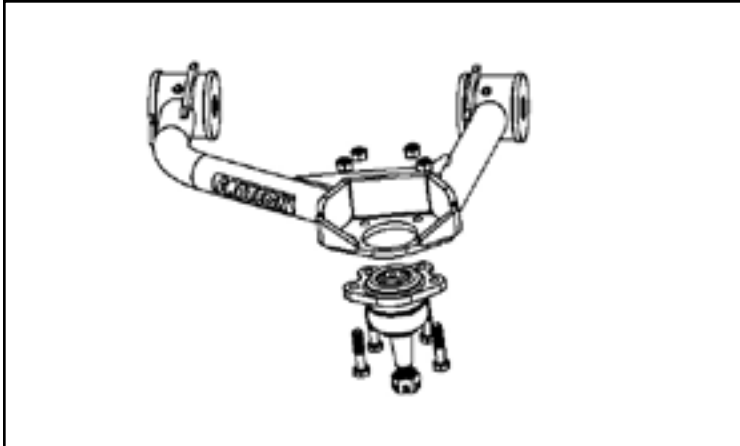

FIGURE 32 - STEP 24

25. Locate the factory bumpstop tabs on the frame mount. Using a cutoff wheel remove this tab completely off the mount and sand to a smooth finish. **SEE FIGURES 33-34**

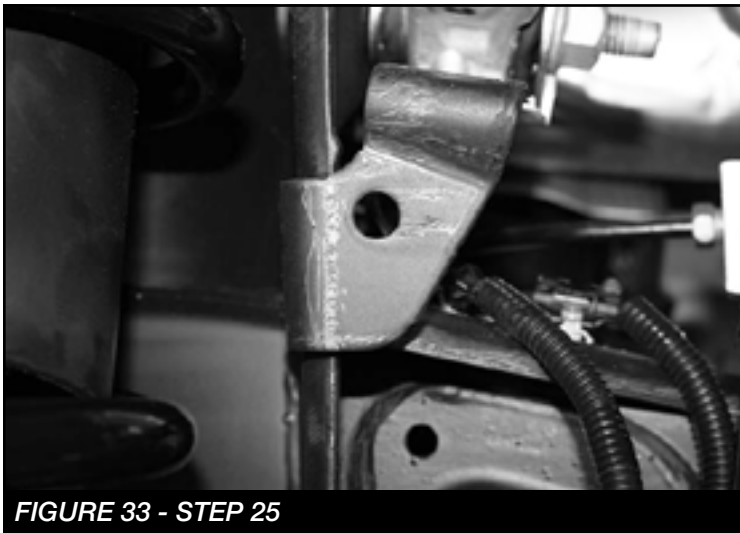

FIGURE 33 - STEP 25



FIGURE 34 - STEP 25

26. Install the FT20833 (Driver) & FT20834 (Pass) upper control arms using the supplied M14 hardware. **NOTE: When installing the arms, install a FT20836 (washer) on both sides of the bushings. SEE FIGURE 35.** Using the supplied thread locking compound, Torque the M14 upper control arm hardware to 160 ft-lbs

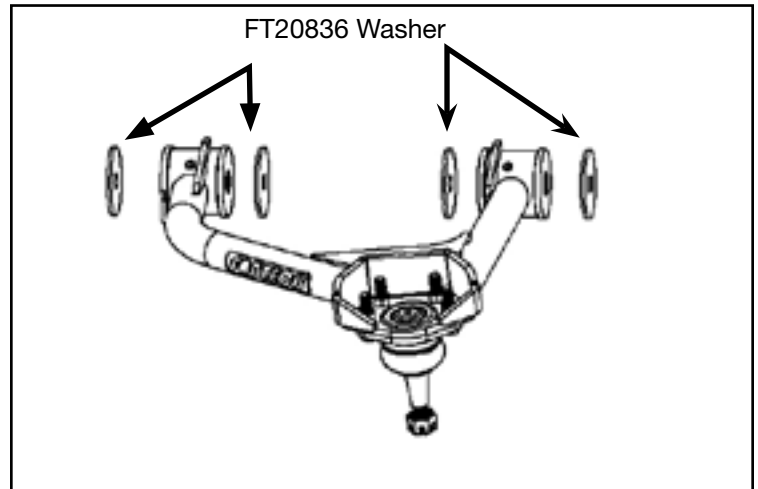

FIGURE 35 - STEP 26

27. Remove the factory nut clips on both of the factory lower struts.
28. Install the coil over into the upper shock mount using the supplied 7/16" Nylock nuts and washers. Leave loose at this time. **SEE FIGURE 36**

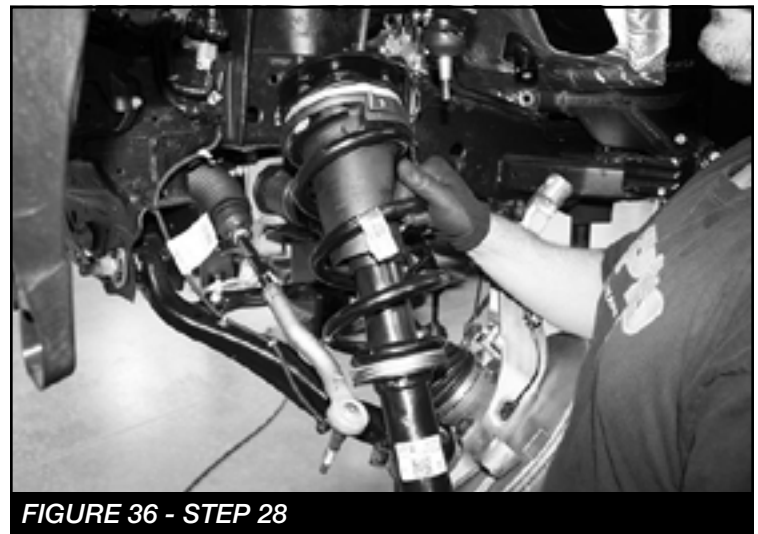

FIGURE 36 - STEP 28

29. Locate the two 7/16"-14 x 2-1/2" bolts, nuts and washers and install the lower bar pin mount onto the lower control arm. Torque the upper and lower bolts to 83 ft-lbs.

SEE FIGURE 37



FIGURE 37 - STEP 29

30. Repeat steps on the opposite side.
31. Reinstall the upper control arm to the knuckle, the sway bar link to the lower control arm and the tie rod end to the knuckle torque all nuts to 35 ft-lbs. Reinstall the axle hub nut and torque to 156 ft-lbs. Remove the bracket from the ABS sensor line and attach to the brake line hose using the supplied zip ties. Reinstall the brake line bracket to the knuckle using the factory hardware. Torque to 11 ft-lbs.

SEE FIGURE 38

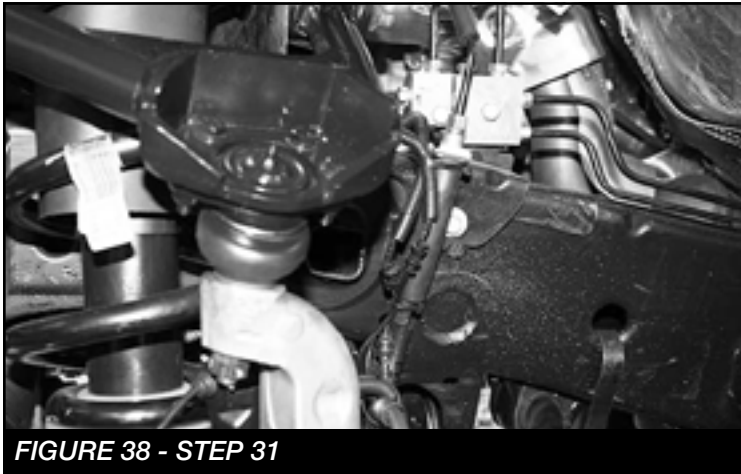

FIGURE 38 - STEP 31

32. **ADAPTIVE RIDE CONTROL ONLY:** Install the ride control rod to the new Fabtech arm using the supplied M6 nut. Torque to 7 ft-lbs.

REAR SUSPENSION

33. Jack up the rear end of the truck and support the frame rails with jack stands. **NEVER WORK UNDER AN UNSUPPORTED VEHICLE!** Remove the rear wheels/tires.
34. With the rear axle supported. Remove the rear shocks and save hardware. **NOTE: If working on a vehicle equipped with Adaptive Ride Control disconnect the shock at the lower mount only. Do not completely remove from vehicle.** Remove the factory ubolts.
35. Install the new FTBK15 (1.5" Blocks) and FT1500U (ubolts) using the supplied 9/16" nuts and washers. Torque to 93 ft-lbs.
36. Install rear shocks using FTS7333 (Performance shocks) or FTS6333 (Stealth Shocks) with factory hardware. Torque to 100 ft-lbs. **Adaptive ride control vehicles:** Install the FT20673BK (Rear shock ext) onto the shock using the supplied 1/2 x 3-1/2" hardware then install to the axle mount using the factory hardware. Torque to 106 ft-lbs.
37. Install tires and wheels and torque lug nuts to wheel manufacturer's specifications. Turn front tires left to right and check for appropriate tire clearance. **Note - Some oversized tires may require trimming of the front bumper & valance.**
38. Check front end alignment and set to factory specifications. Readjust headlights.
39. Recheck all bolts for proper torque.
40. Recheck brake hoses, ABS wires and suspension parts for proper tire clearance while turning tires fully left to right.
41. Check the fluid in the front and rear differential and fill if needed with factory specification differential oil. **Note - some differentials may expel fluid after filling and driving. This can be normal in resetting the fluid level with the new position of the differential/s.**
42. Install Driver Warning Decal. Complete product registration card and mail to Fabtech in order to receive future safety and technical bulletins on this suspension.

Vehicles that will receive oversized tires should check ball joints, uniballs and all steering components every 2500-5000 miles for wear and replace as required.

RE-TORQUE ALL NUTS, BOLTS AND LUGS AFTER 50 MILES AND PERIODICALLY THEREAFTER.

For technical assistance call: **909-597-7800**

- Product Warranty and Warnings -

Fabtech provides a Limited Lifetime Warranty to the original retail purchaser who owns the vehicle, on which the product was originally installed, for defects in workmanship and materials.

The Limited Lifetime Warranty excludes the following Fabtech items; bushings, bump stops, ball joints, tie rod ends, limiting straps, cross shafts, heim joints and driveshafts. These parts are subject to wear and are not considered defective when worn. They are warranted for 60 days from the date of purchase for defects in workmanship.

Dirt Logic and Performance Coilover take apart shocks are considered a serviceable shock with a one year warranty on leakage only. Service seal kits are available separately for future maintenance. All other shocks are covered under our Limited Lifetime Warranty.

Fabtech does not warrant any product for finish, alterations, modifications and/or installation contrary to Fabtech's instructions. Alterations to the finish of the parts including but not limited to painting, powder coating, plating and/or welding will void all warranties. Some finish damage may occur to parts during shipping, which is considered normal and is not covered under warranty.

Fabtech products are not designed nor intended to be installed on vehicles used in race applications or for racing purposes or for similar activities. (A "RACE" is defined as any contest between two or more vehicles, or any contest of one or more vehicle against the clock, whether or not such contest is for a prize). This warranty does not include coverage for police or taxi vehicles, race vehicles, or vehicles used for government or commercial purposes. Also excluded from this warranty are sales outside of the United States of America.

Installation of most suspension products will raise the center of gravity of the vehicle and will cause the vehicle to handle differently than stock. It may increase the vehicle's susceptibility to a rollover, on road and off road, at all speeds. Extreme care should be taken to operate the vehicle safely at all times to prevent rollover or loss of control resulting in serious injury or death. Fabtech front end Desert Guards may impair the deployment or operation of vehicles equipped with supplemental restraining systems/air bag systems and should not be installed if the vehicle is equipped as so.

Fabtech makes every effort to ensure suspension product compatibility with all vehicles listed on the website, but due to unknown auto manufacturer's production changes and/or inconsistencies by the auto manufacturer, Fabtech cannot be responsible for 100% compatibility, including the fitment of tire and wheel sizes listed. The Tire and Wheel sizes listed in Fabtech's website are only a guideline for street driving with noted fender trimming. Fabtech is not responsible for damages to the vehicle's body or tires. Fabtech is not responsible for premature wear of factory components due to the installation of oversized tires and wheels.

Fabtech's obligation under this warranty is limited to the repair or replacement, at Fabtech option, of the defective product only. All costs of removal, installation or re-installation, freight charges, incidental or consequential damages are expressly excluded from this warranty. Fabtech is not responsible for damages and/or warranty of other vehicle parts related or non related to the installed Fabtech product. This warranty is expressly in lieu of all other warranties expressed or implied. This warranty shall not apply to any product that has been subject to accident, negligence, alteration, abuse or misuse as determined by Fabtech.

Fabtech suspension components must be installed as a complete system including shocks as shown on our website. All warranties will become void if Fabtech parts are combined and/or substituted with other aftermarket suspension products. Combination and/or substitution of other aftermarket suspension parts may cause premature wear and/or product failure resulting in an accident causing injury or death. Fabtech does not warrant products not manufactured by Fabtech.

Depending on the condition of the factory suspension components retained after the installation of a Fabtech suspension not all vehicles may have the same ride stance front to rear as described in the website. The blue color of suspension components shown in all Fabtech photographs are for display purposes only. Majority of all Fabtech components will be black specifically where noted with part numbers ending in BK.

Installation of Fabtech product may void the vehicles factory warranty; it is the consumer's responsibility to check with their local vehicle's dealer for warranty disposition before the installation of the product. Some state laws may prohibit modification of suspension to a vehicle in whole or in part. It is the responsibility of the installer and consumer to consult local laws prior to the installation of any Fabtech suspension product to comply with such written laws.

It is the responsibility of the distributor and/or the retailer to review all warranties and warnings of Fabtech products with the consumer prior to purchase.

Fabtech reserves the right to super cede, discontinue, change the design, finish, part number and/or application of parts when deemed necessary without written notice. Fabtech is not responsible for misprints or typographical errors within the website or price sheet. For the most recent Product Warranty and Warnings visit our website www.fabtechmotorsports.com